

2-BEDROOM +STUDY

TYPE B1-G

77m² / 829ft²
(inclusive of 9m² PES
& 4m² AC Ledge)

Blk 19, #01-40



Legend

W - Washer F - Fridge DB - Distribution Board

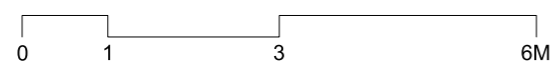

ALL PLANS ARE SUBJECT TO CHANGES BY THE RELEVANT AUTHORITIES.
MEASUREMENTS ARE APPROXIMATE ONLY AND SUBJECT TO FINAL SURVEY.
INFORMATION ACCURATE AT THE POINT OF PRINTING.
BP No.: A0712-05181-2018-BP01 (Dated 2 Dec 2019)

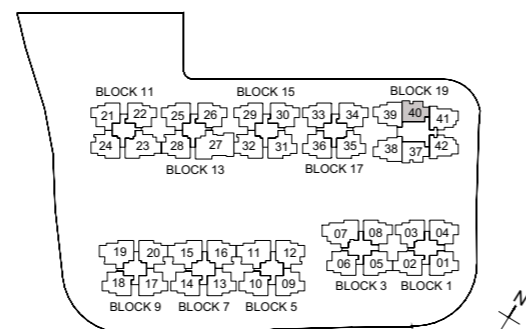

3-BEDROOM

TYPE C1-G

76m² / 818ft²
(inclusive of 6m² PES
& 4m² AC Ledge)

Blk 19, #01-37*

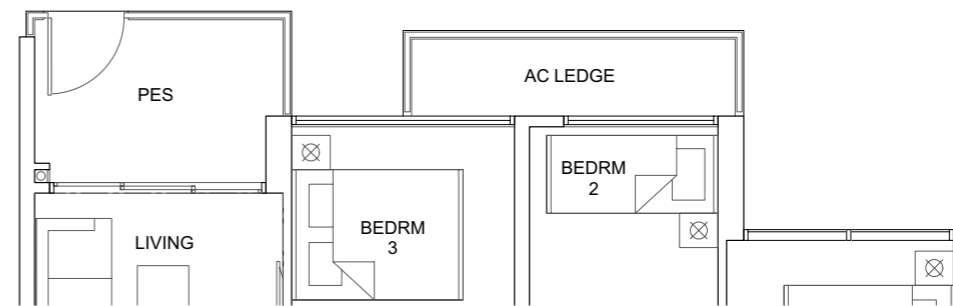

TYPE C1

76m² / 818ft²
(inclusive of 6m² Balcony
& 4m² AC Ledge)

Blk 19, #02-37* to #12-37*
#02-40 to #12-40

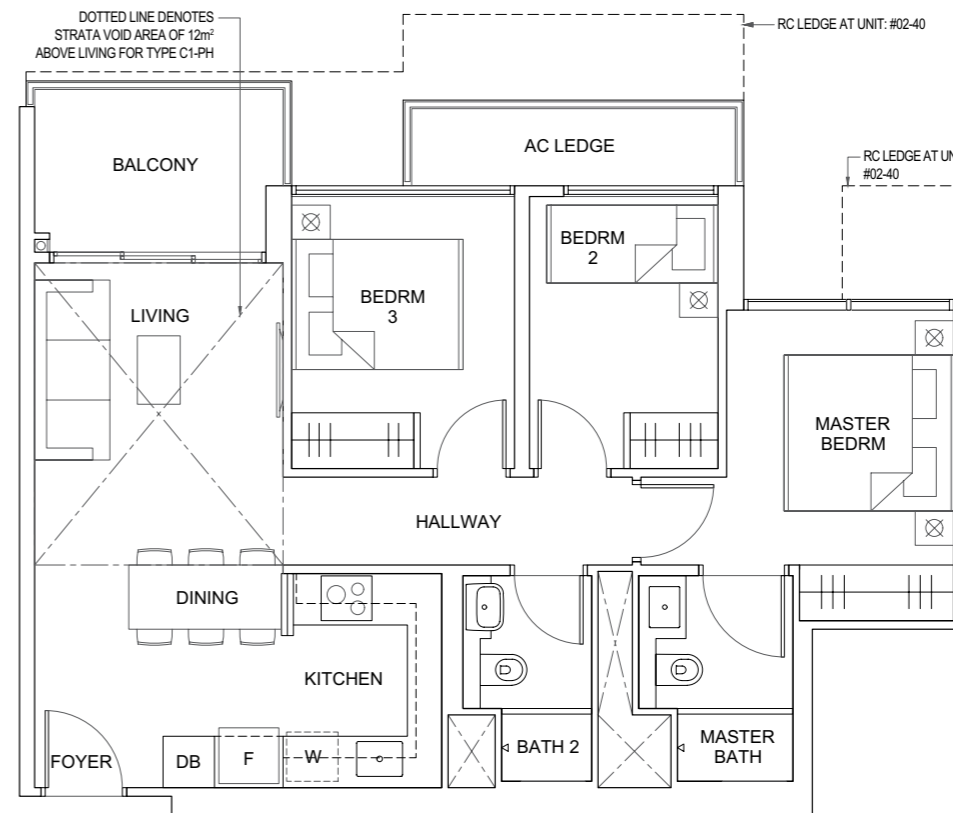

TYPE C1-PH

88m² / 947ft²
(inclusive of 6m² Balcony
& 4m² AC Ledge
& 12m² Void over Living)

Blk 19, #13-37*
#13-40

* Mirrored unit

Legend

W - Washer F - Fridge DB - Distribution Board

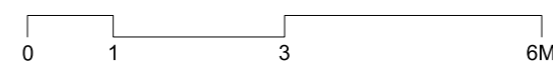

ALL PLANS ARE SUBJECT TO CHANGES BY THE RELEVANT AUTHORITIES.
MEASUREMENTS ARE APPROXIMATE ONLY AND SUBJECT TO FINAL SURVEY.
INFORMATION ACCURATE AT THE POINT OF PRINTING.
BP No.: A0712-05181-2018-BP01 (Dated 2 Dec 2019)

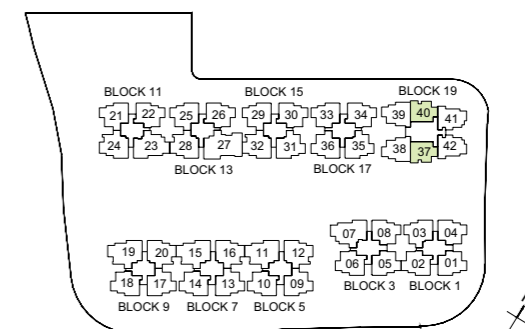

3-BEDROOM

TYPE C2-G

82m² / 883ft²
(inclusive of 6m² PES
& 5m² AC Ledge)

Blk 19, #01-41
#01-42*

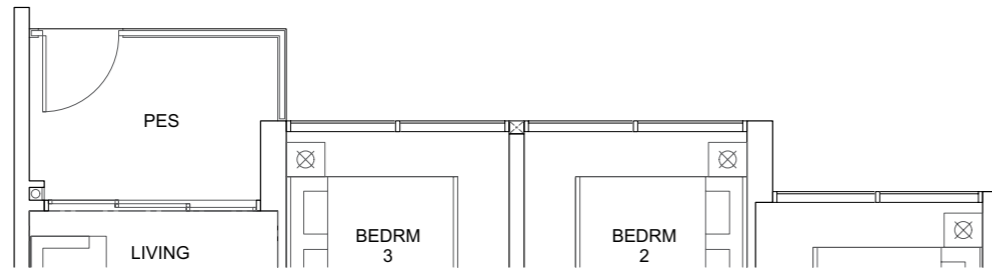

TYPE C2

82m² / 883ft²
(inclusive of 6m² Balcony
& 5m² AC Ledge)

Blk 19, #02-41 to #12-41
#02-42* to #12-42*

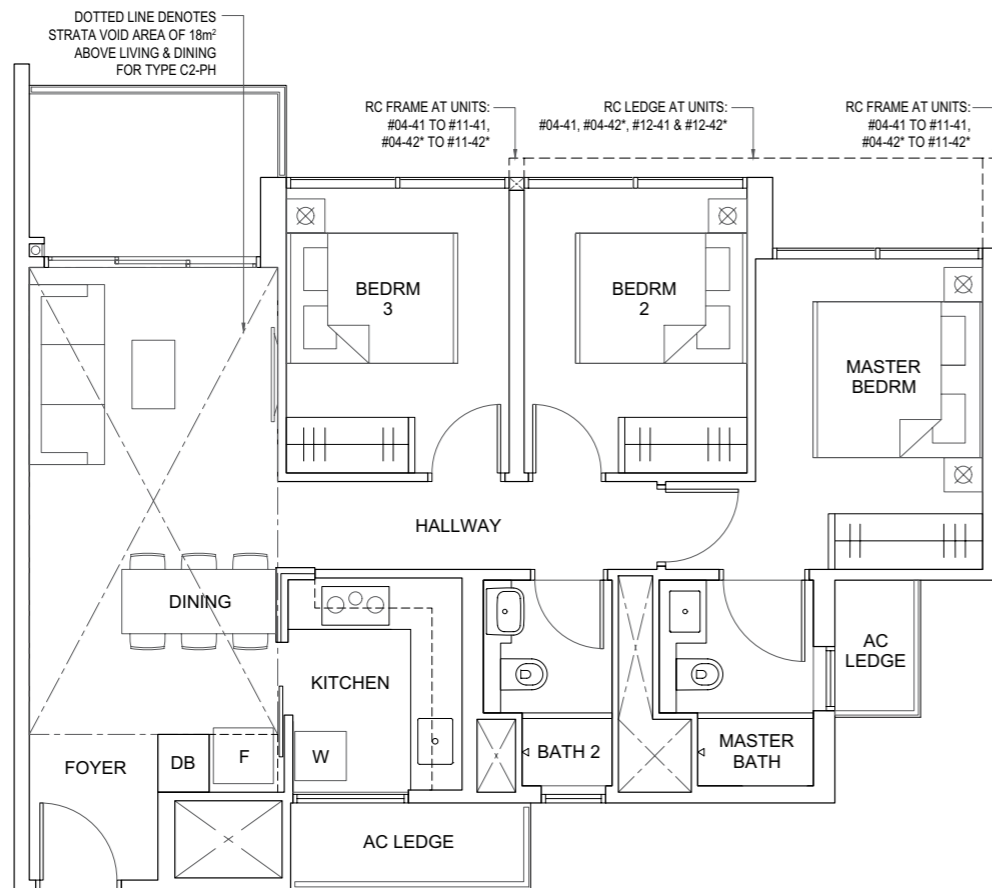

TYPE C2-PH

100m² / 1076ft²
(inclusive of 6m² Balcony
& 5m² AC Ledge &
18m² Void over
Living & Dining)

Blk 19, #13-41
#13-42*

* Mirrored unit

Legend

W - Washer F - Fridge DB - Distribution Board

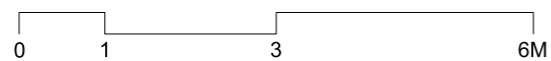

ALL PLANS ARE SUBJECT TO CHANGES BY THE RELEVANT AUTHORITIES.
MEASUREMENTS ARE APPROXIMATE ONLY AND SUBJECT TO FINAL SURVEY.
INFORMATION ACCURATE AT THE POINT OF PRINTING.
BP No.: A0712-05181-2018-BP01 (Dated 2 Dec 2019)

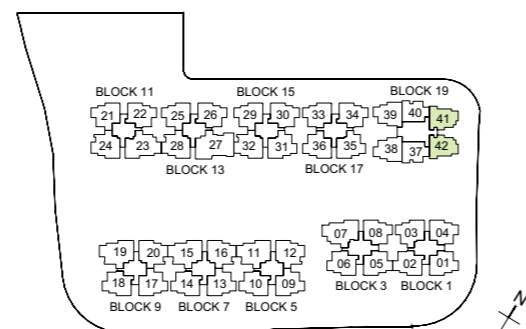

3-BEDROOM

TYPE C3-G

86m² / 926ft²
(inclusive of 9m² PES
& 4m² AC Ledge)

Blk 19, #01-38
#01-39*

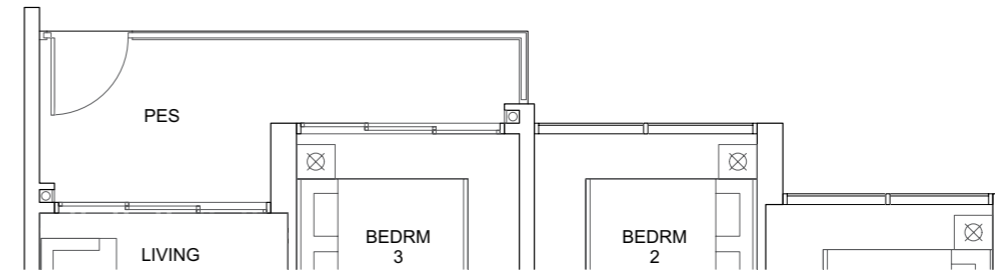

TYPE C3

86m² / 926ft²
(inclusive of 9m² Balcony
& 4m² AC Ledge)

Blk 19, #02-38 to #12-38
#02-39* to #12-39*

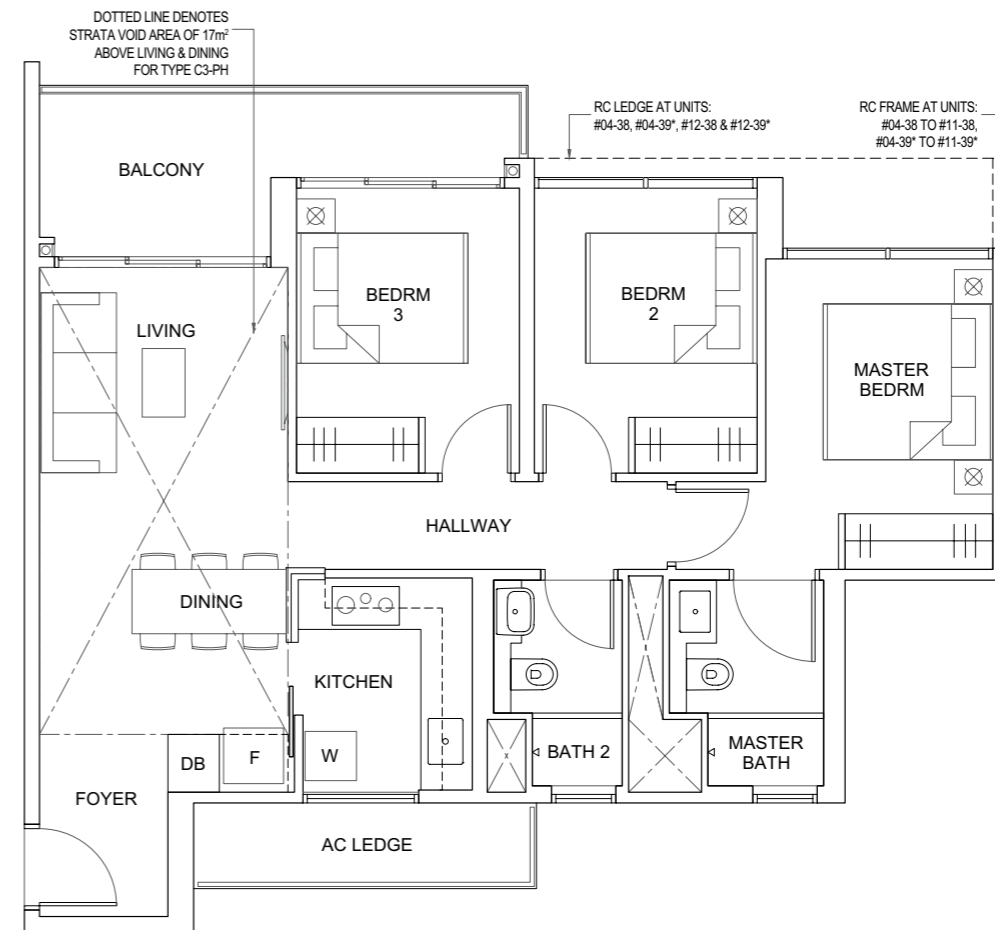

TYPE C3-PH

103m² / 1109ft²
(inclusive of 9m² Balcony
& 4m² AC Ledge &
17m² Void over
Living & Dining)

Blk 19, #13-38
#13-39*

* Mirrored unit

Legend

W - Washer F - Fridge DB - Distribution Board

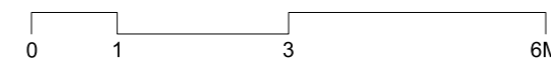

ALL PLANS ARE SUBJECT TO CHANGES BY THE RELEVANT AUTHORITIES.
MEASUREMENTS ARE APPROXIMATE ONLY AND SUBJECT TO FINAL SURVEY.
INFORMATION ACCURATE AT THE POINT OF PRINTING.
BP No.: A0712-05181-2018-BP01 (Dated 2 Dec 2019)

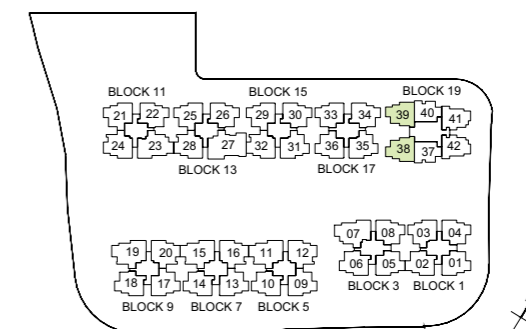

3-BEDROOM +STUDY

TYPE C4-G

86m² / 926ft²
(inclusive of 9m² PES
& 5m² AC Ledge)

Blk 1, #01-01*
#01-04
Blk 3, #01-08
Blk 17, #01-33*

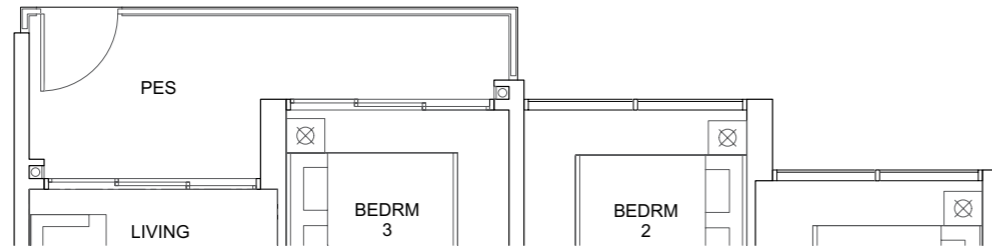

TYPE C4

86m² / 926ft²
(inclusive of 9m² Balcony
& 5m² AC Ledge)

Blk 1, #02-01* to #12-01*
#02-04 to #12-04
Blk 3, #02-05* to #12-05*
#02-08 to #12-08
Blk 17, #02-33* to #12-33*

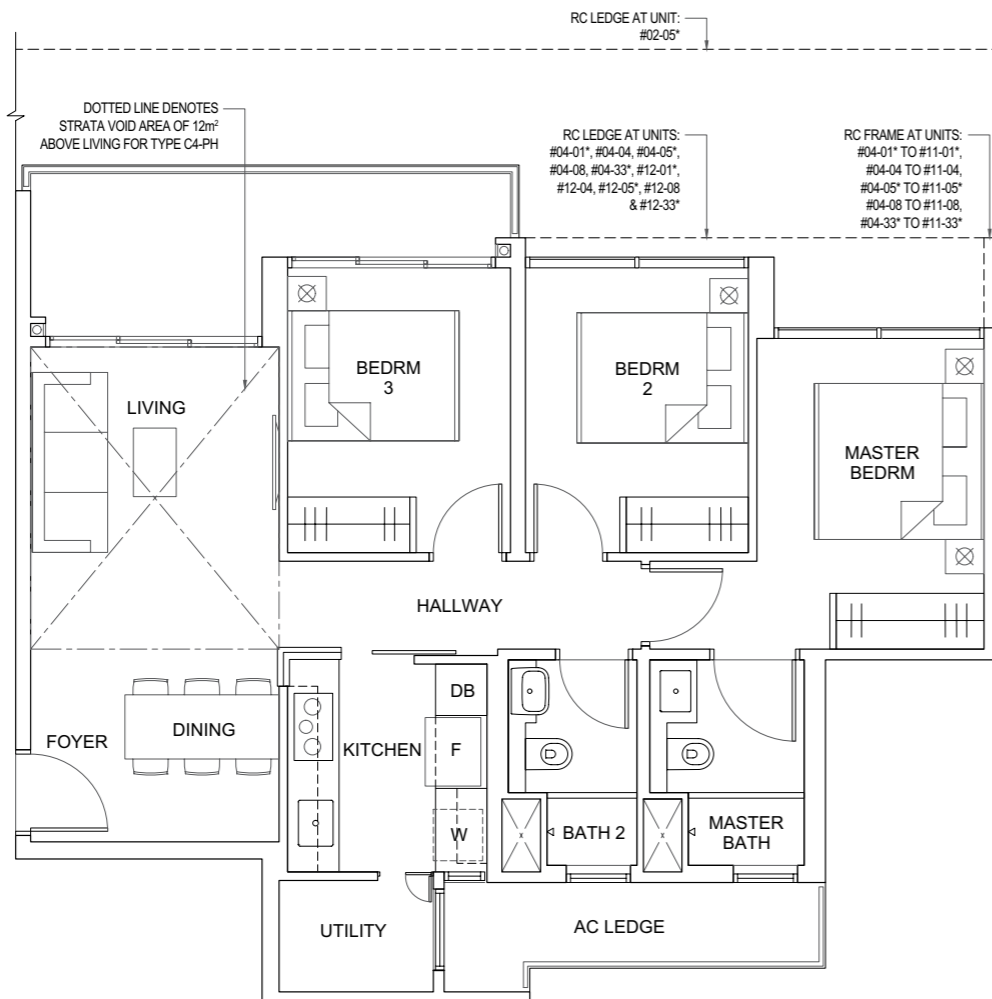

TYPE C4-PH

98m² / 1055ft²
(inclusive of 9m² Balcony
& 5m² AC Ledge
& 12m² Void over Living)

Blk 1, #13-01*
#13-04
Blk 3, #13-05*
#13-08
Blk 17, #13-33*

* Mirrored unit

Legend

W - Washer F - Fridge DB - Distribution Board

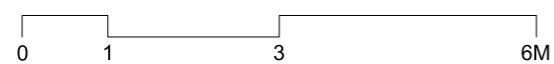

ALL PLANS ARE SUBJECT TO CHANGES BY THE RELEVANT AUTHORITIES.
MEASUREMENTS ARE APPROXIMATE ONLY AND SUBJECT TO FINAL SURVEY.
INFORMATION ACCURATE AT THE POINT OF PRINTING.
BP No.: A0712-05181-2018-BP01 (Dated 2 Dec 2019)

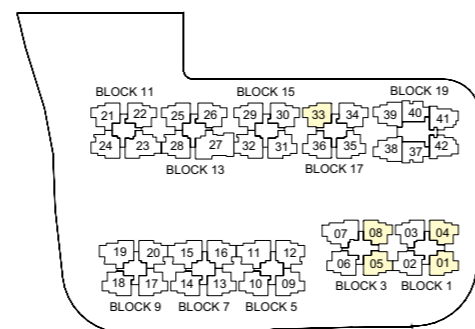

3-BEDROOM +STUDY

TYPE C5-G

88m² / 947ft²
(inclusive of 9m² PES
& 5m² AC Ledge)

Blk 1, #01-02
Blk 5, #01-10
Blk 7, #01-14
Blk 9, #01-18
Blk 11, #01-22
Blk 13, #01-26
Blk 15, #01-30
Blk 17, #01-34

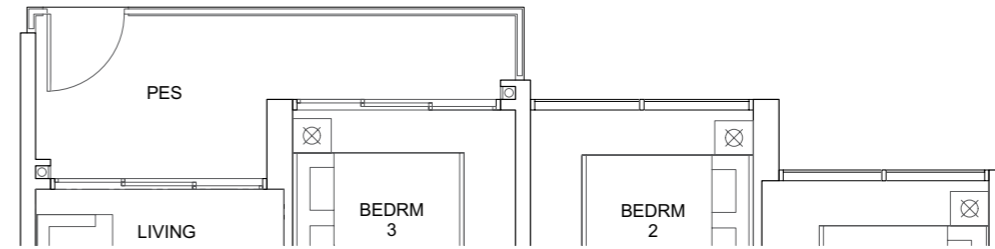

TYPE C5

88m² / 947ft²
(inclusive of 9m² Balcony
& 5m² AC Ledge)

Blk 1, #02-02 to #12-02
Blk 3, #02-06 to #12-06
Blk 5, #02-10 to #10-10
Blk 7, #02-14 to #10-14
Blk 9, #02-18 to #10-18
Blk 11, #02-22 to #10-22
Blk 13, #02-26 to #10-26
Blk 15, #02-30 to #10-30
Blk 17, #02-34 to #12-34

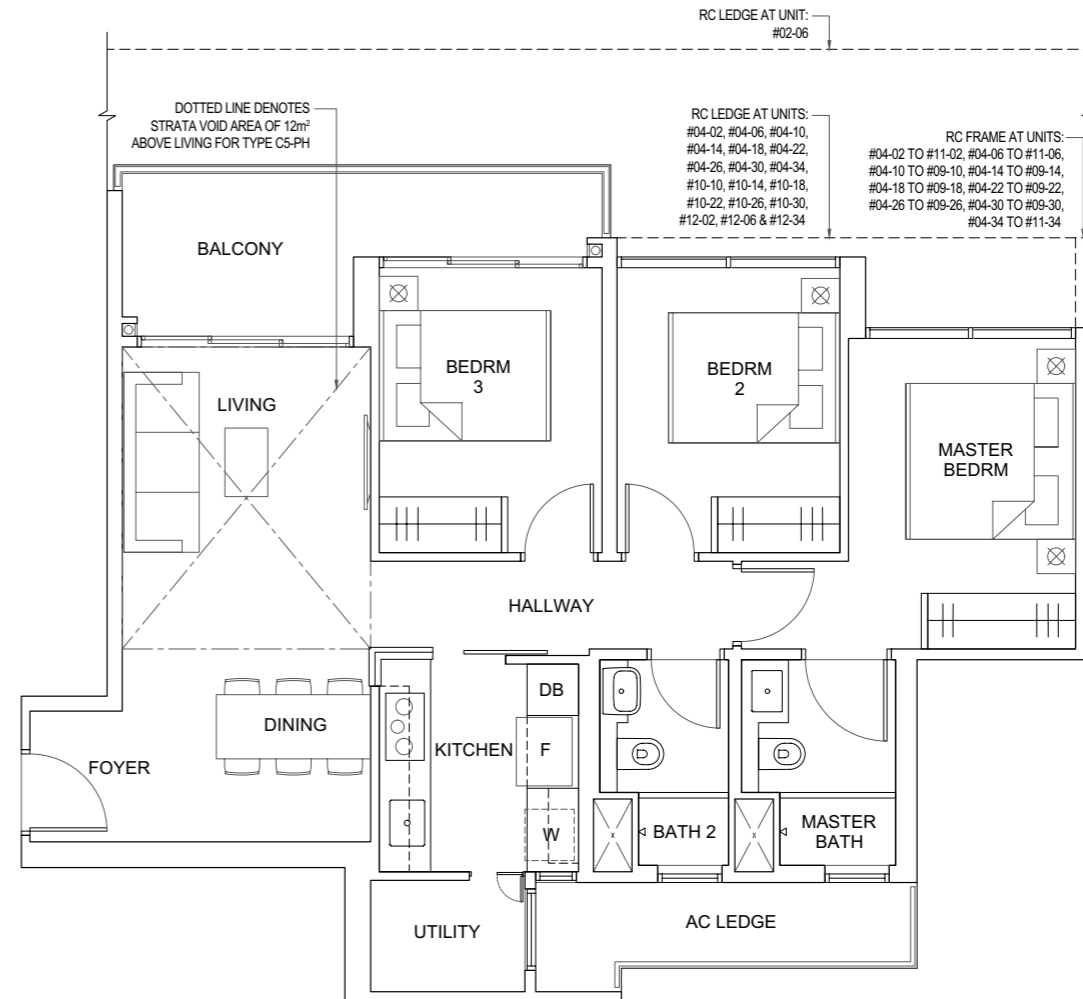

TYPE C5-PH

100m² / 1076ft²
(inclusive of 9m² Balcony
& 5m² AC Ledge
& 12m² Void over Living)

Blk 1, #13-02
Blk 3, #13-06
Blk 5, #11-10
Blk 7, #11-14
Blk 9, #11-18
Blk 11, #11-22
Blk 13, #11-26
Blk 15, #11-30
Blk 17, #13-34

Legend

W - Washer F - Fridge DB - Distribution Board

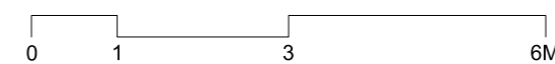

ALL PLANS ARE SUBJECT TO CHANGES BY THE RELEVANT AUTHORITIES.
MEASUREMENTS ARE APPROXIMATE ONLY AND SUBJECT TO FINAL SURVEY.
INFORMATION ACCURATE AT THE POINT OF PRINTING.
BP No.: A0712-05181-2018-BP01 (Dated 2 Dec 2019)

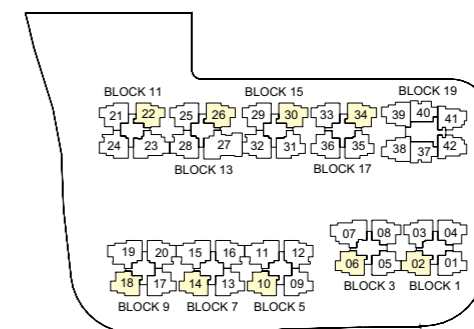

**3-BEDROOM
+UTILITY
+YARD**

TYPE C6-G

88m² / 947ft²
(inclusive of 9m² PES
& 5m² AC Ledge)

- Blk 5, #01-09*
- Blk 7, #01-13*
- Blk 9, #01-17*
- Blk 11, #01-21*
- Blk 13, #01-25*
- Blk 15, #01-29*
- Blk 17, #01-36

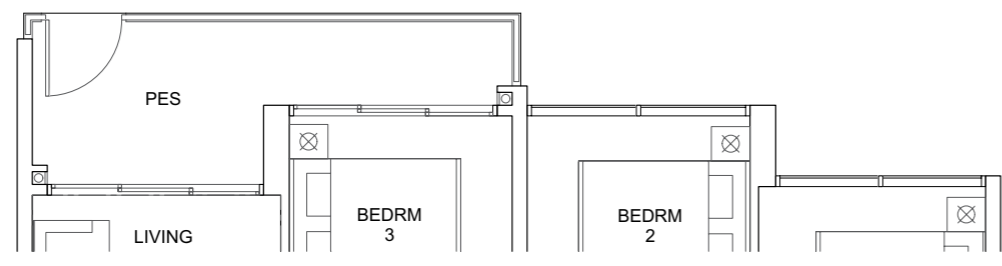

TYPE C6

88m² / 947ft²
(inclusive of 9m² Balcony
& 5m² AC Ledge)

- Blk 5, #02-09* to #10-09*
- Blk 7, #02-13* to #10-13*
- Blk 9, #02-17* to #10-17*
- Blk 11, #02-21* to #10-21*
- Blk 13, #02-25* to #10-25*
- Blk 15, #02-29* to #10-29*
- Blk 17, #02-36 to #12-36

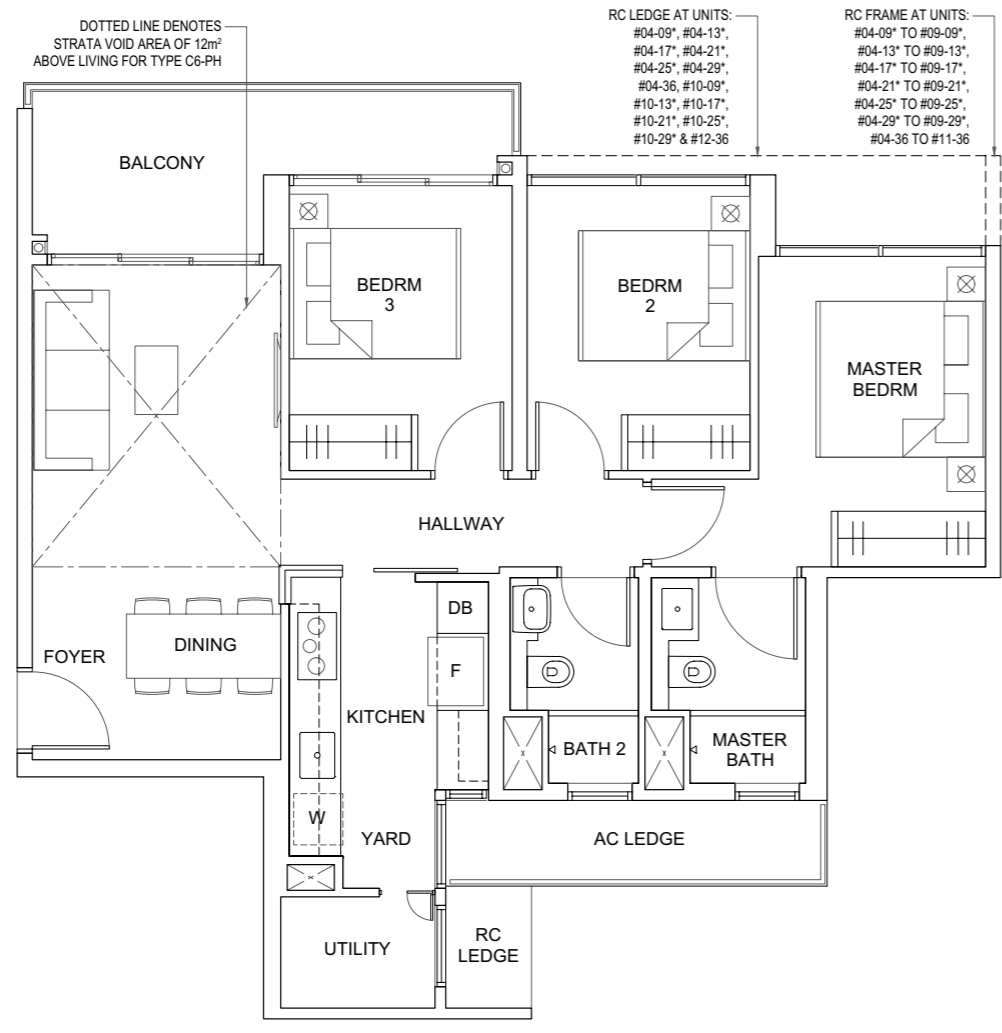

TYPE C6-PH

100m² / 1076ft²
(inclusive of 9m² Balcony
& 5m² AC Ledge
& 12m² Void over Living)

- Blk 5, #11-09*
- Blk 7, #11-13*
- Blk 9, #11-17*
- Blk 11, #11-21*
- Blk 13, #11-25*
- Blk 15, #11-29*
- Blk 17, #13-36

* Mirrored unit

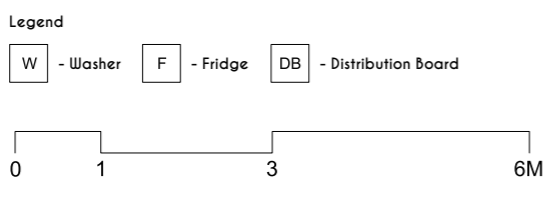

ALL PLANS ARE SUBJECT TO CHANGES BY THE RELEVANT AUTHORITIES. MEASUREMENTS ARE APPROXIMATE ONLY AND SUBJECT TO FINAL SURVEY. INFORMATION ACCURATE AT THE POINT OF PRINTING. BP No.: A0712-05181-2018-BP01 (Dated 2 Dec 2019)

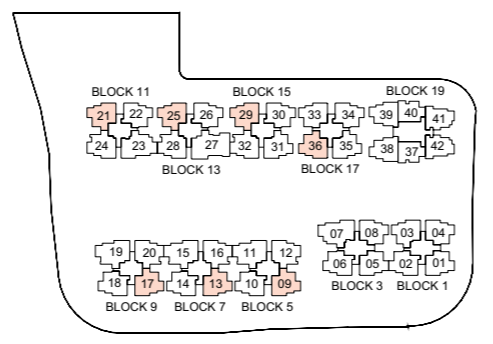

**3-BEDROOM
+UTILITY
+YARD**

TYPE C7-G

88m² / 947ft²
(inclusive of 9m² PES
& 5m² AC Ledge)

- Blk 1, #01-03
- Blk 15, #01-31
- Blk 17, #01-35

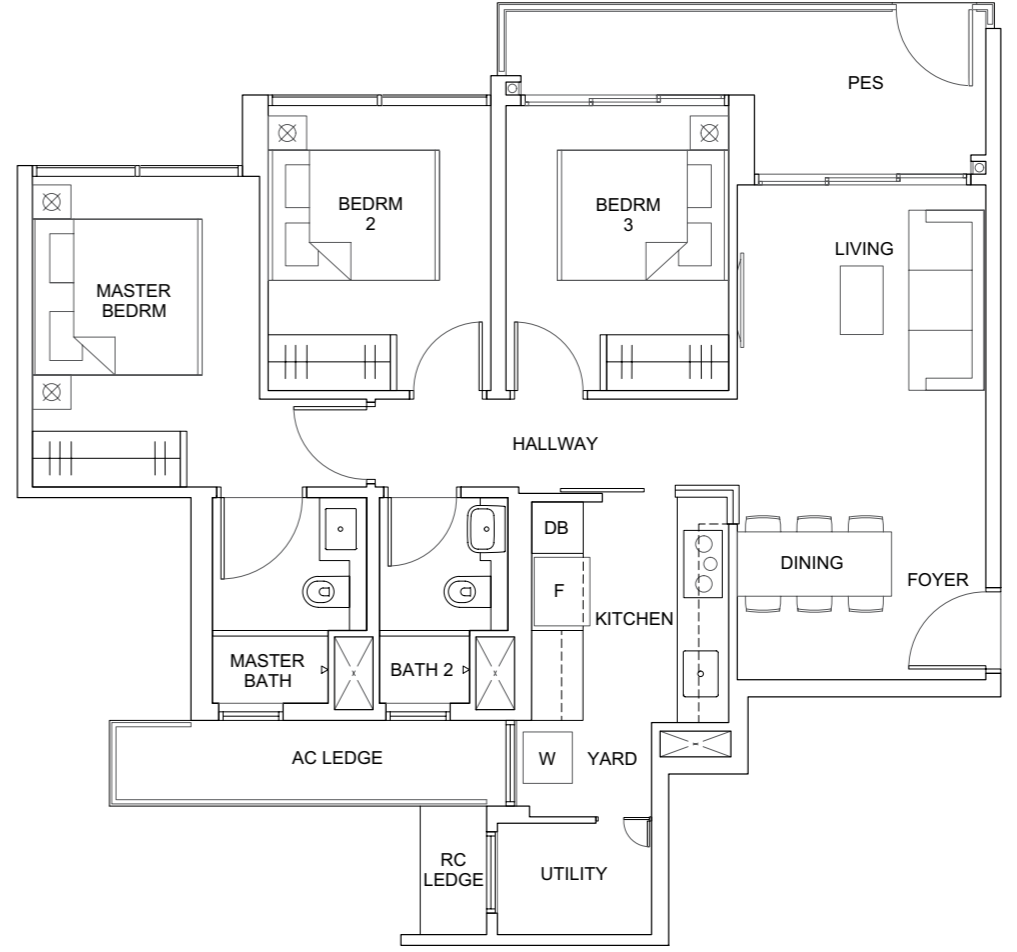

TYPE C7

89m² / 958ft²
(inclusive of 9m² Balcony
& 5m² AC Ledge)

- Blk 1, #02-03 to #12-03
- Blk 15, #02-31 to #10-31
- Blk 17, #02-35 to #12-35

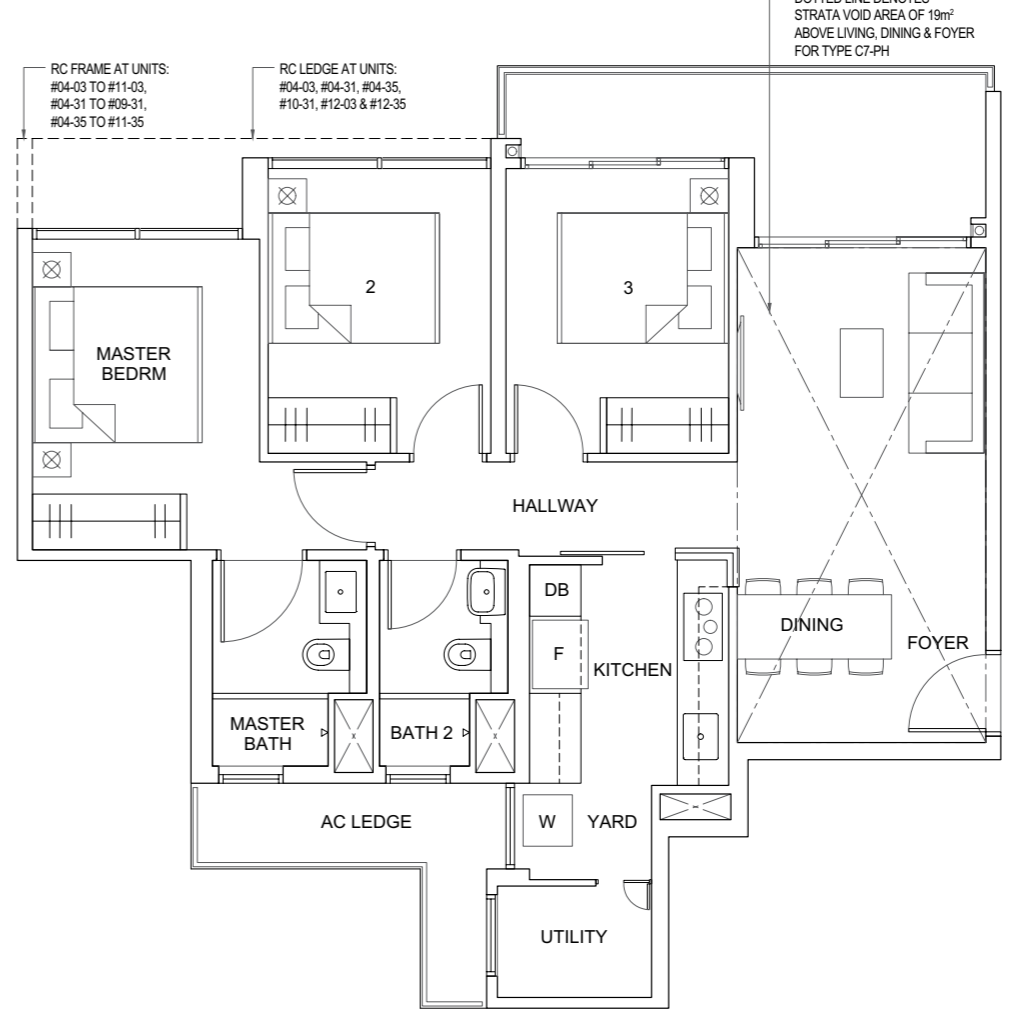

TYPE C7-PH

108m² / 1163ft²
(inclusive of 9m² Balcony
& 5m² AC Ledge
& 19m² Void over Living,
Dining & Foyer)

- Blk 1, #13-03
- Blk 15, #11-31
- Blk 17, #13-35

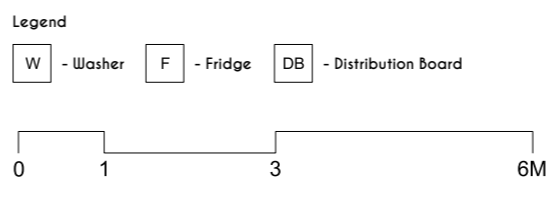

ALL PLANS ARE SUBJECT TO CHANGES BY THE RELEVANT AUTHORITIES. MEASUREMENTS ARE APPROXIMATE ONLY AND SUBJECT TO FINAL SURVEY. INFORMATION ACCURATE AT THE POINT OF PRINTING. BP No.: A0712-05181-2018-BP01 (Dated 2 Dec 2019)

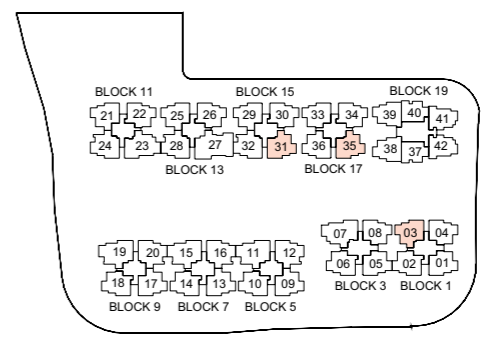

**3-BEDROOM
+UTILITY
+YARD**

TYPE C8-G

93m² / 1001ft²
(inclusive of 9m² PES
& 5m² AC Ledge)

- Blk 5, #01-12
- Blk 7, #01-16
- Blk 9, #01-20
- Blk 11, #01-24
- Blk 13, #01-28
- Blk 15, #01-32

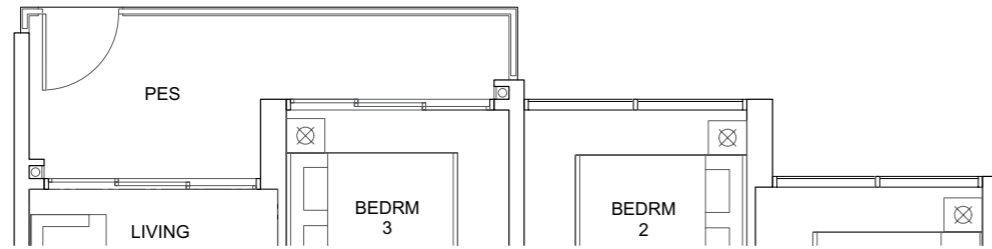

TYPE C8

93m² / 1001ft²
(inclusive of 9m² Balcony
& 5m² AC Ledge)

- Blk 5, #02-12 to #10-12
- Blk 7, #02-16 to #10-16
- Blk 9, #02-20 to #10-20
- Blk 11, #02-24 to #10-24
- Blk 13, #02-28 to #10-28
- Blk 15, #02-32 to #10-32

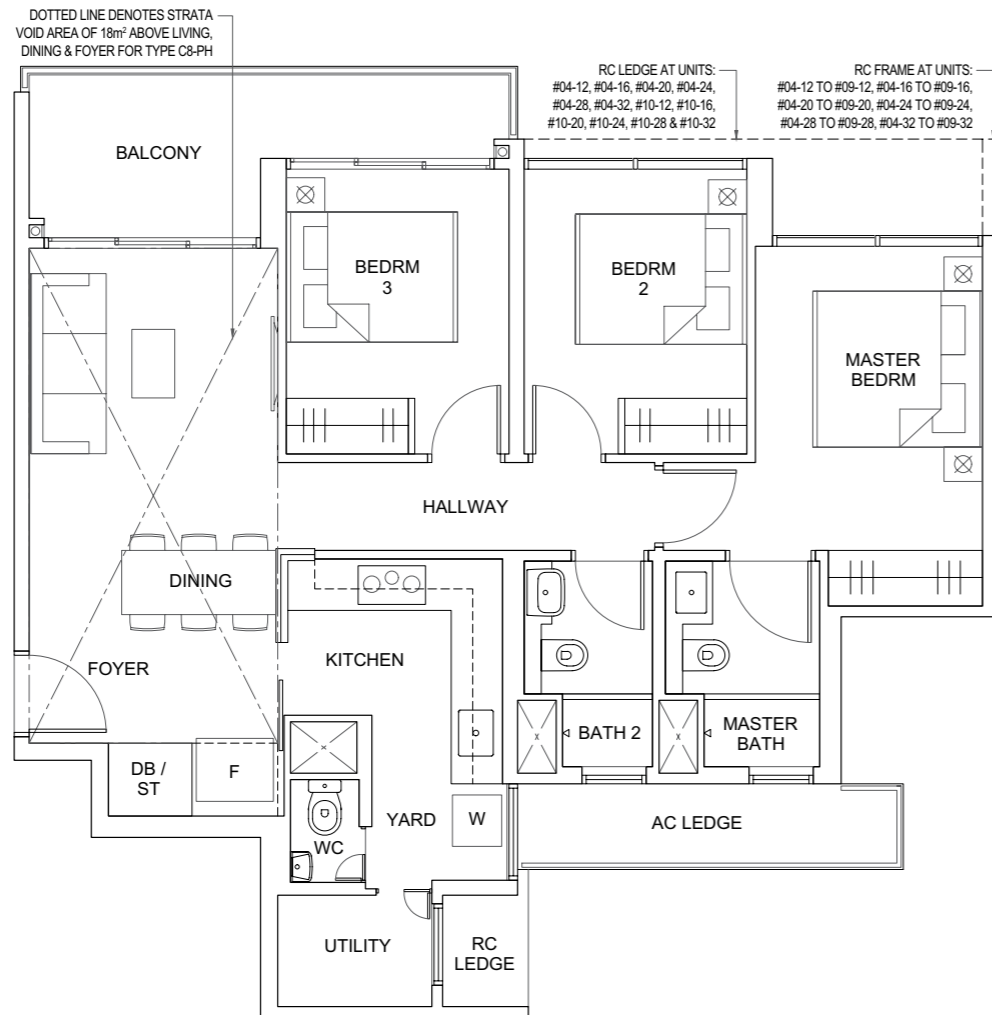

TYPE C8-PH

111m² / 1195ft²
(inclusive of 9m² Balcony
& 5m² AC Ledge
& 18m² Void over Living,
Dining & Foyer)

- Blk 5, #11-12
- Blk 7, #11-16
- Blk 9, #11-20
- Blk 11, #11-24
- Blk 13, #11-28
- Blk 15, #11-32

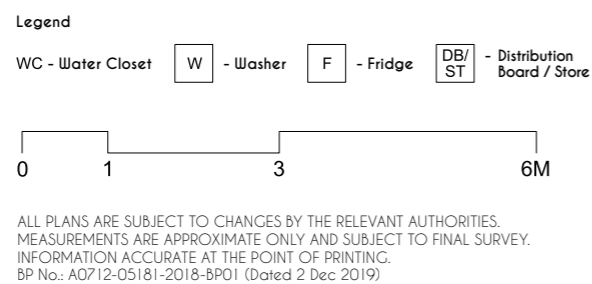

**4-BEDROOM
+UTILITY
+YARD**

TYPE D1-G

107m² / 1152ft²
(inclusive of 10m² PES
& 5m² AC Ledge)

- Blk 5, #01-11
- Blk 7, #01-15
- Blk 9, #01-19

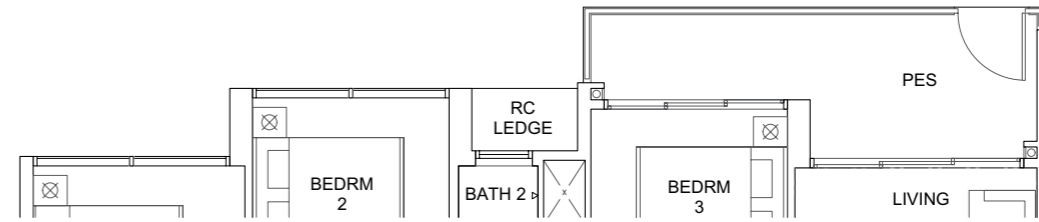

TYPE D1

107m² / 1152ft²
(inclusive of 10m² Balcony
& 5m² AC Ledge)

- Blk 5, #02-11 to #10-11
- Blk 7, #02-15 to #10-15
- Blk 9, #02-19 to #10-19

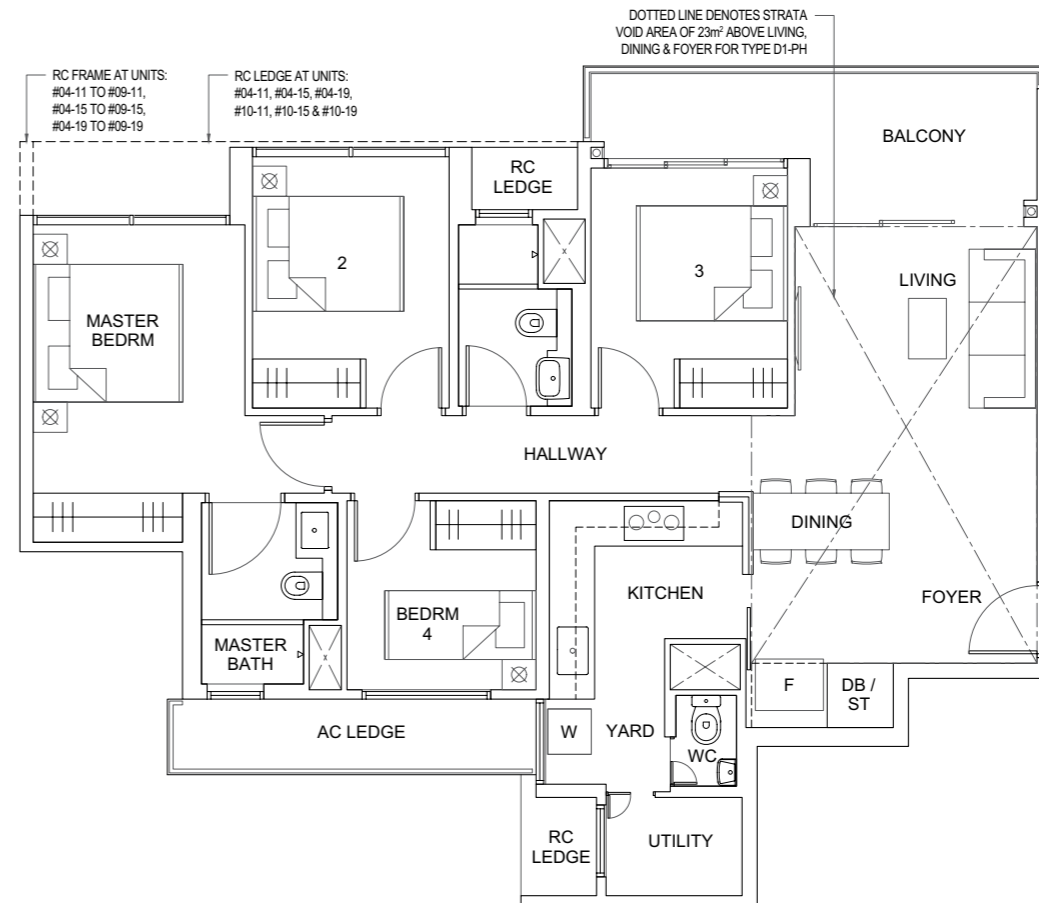

TYPE D1-PH

130m² / 1399ft²
(inclusive of 10m² Balcony
& 5m² AC Ledge
& 23m² Void over Living,
Dining & Foyer)

- Blk 5, #11-11
- Blk 7, #11-15
- Blk 9, #11-19

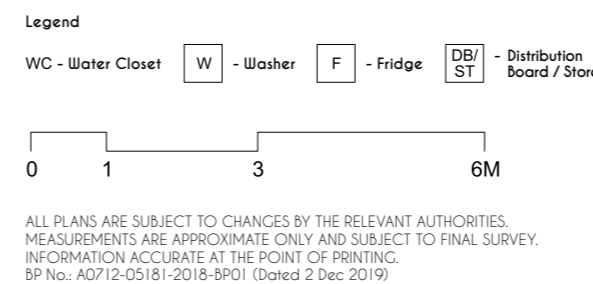

**4-BEDROOM
+UTILITY
+YARD**

TYPE D2-G

110m² / 1184ft²
(inclusive of 13m² PES
& 5m² AC Ledge)

Blk 3, #01-07
Blk 11, #01-23

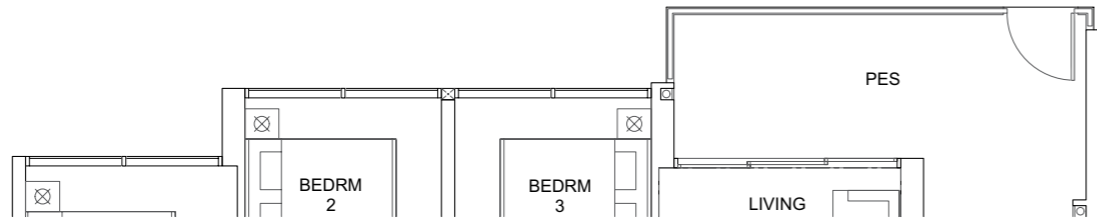

TYPE D2

110m² / 1184ft²
(inclusive of 13m² Balcony
& 5m² AC Ledge)

Blk 3, #02-07 to #12-07
Blk 11, #02-23 to #10-23

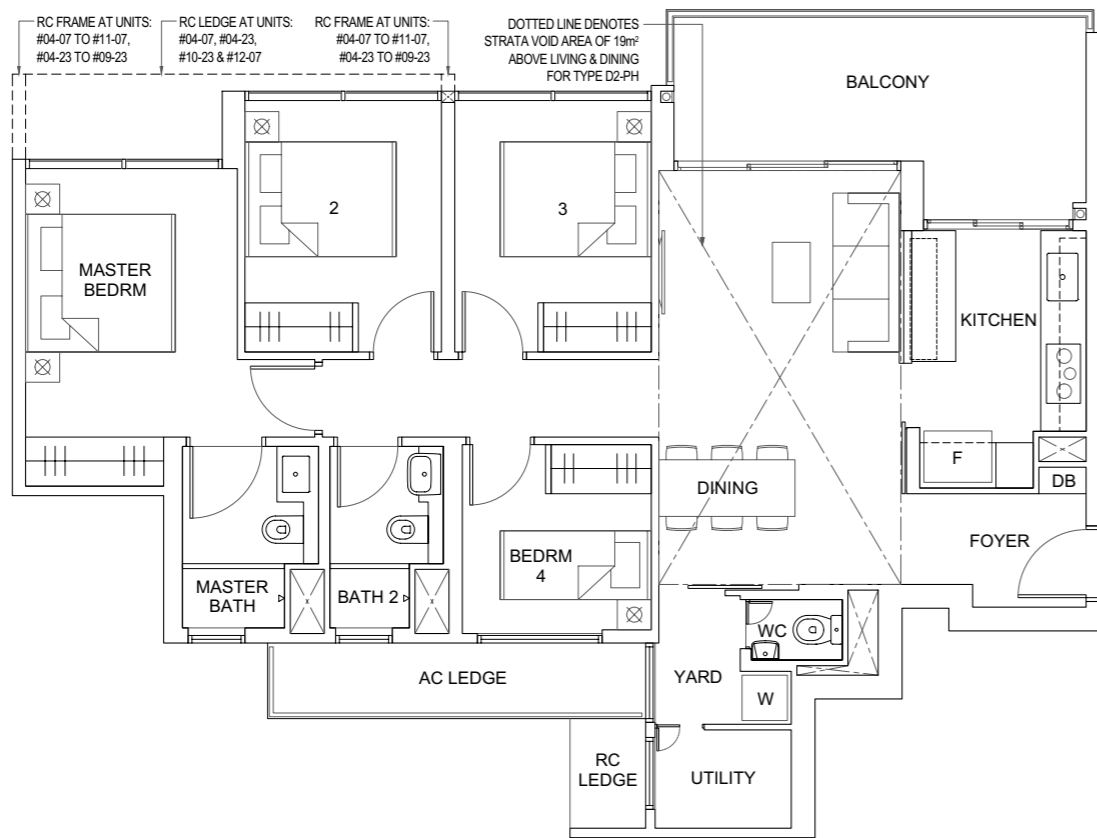

TYPE D2-PH

129m² / 1389ft²
(inclusive of 13m² Balcony
& 5m² AC Ledge
& 19m² Void over
Living & Dining)

Blk 3, #13-07
Blk 11, #11-23

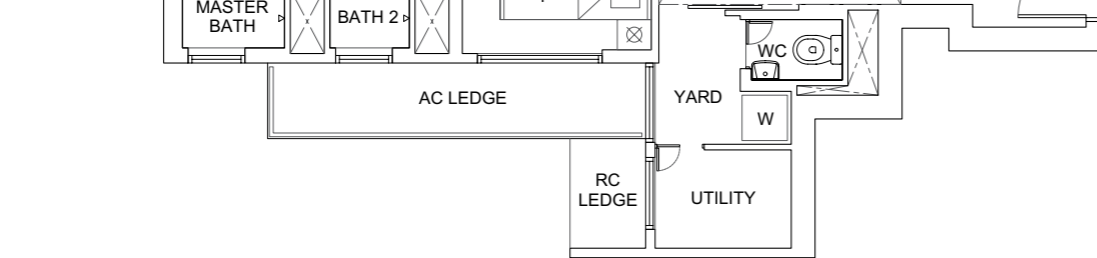

Legend

WC - Water Closet W - Washer F - Fridge DB - Distribution Board

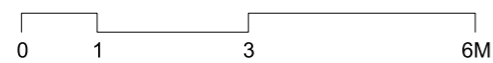

ALL PLANS ARE SUBJECT TO CHANGES BY THE RELEVANT AUTHORITIES.
MEASUREMENTS ARE APPROXIMATE ONLY AND SUBJECT TO FINAL SURVEY.
INFORMATION ACCURATE AT THE POINT OF PRINTING.
BP No.: A0712-05181-2018-BP01 (Dated 2 Dec 2019)

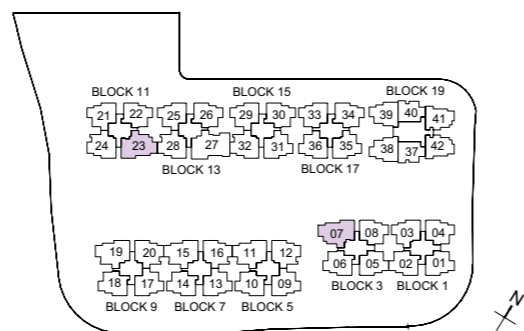

**5-BEDROOM
+UTILITY
+YARD**

TYPE E1-G

135m² / 1453ft²
(inclusive of 17m² PES
& 6m² AC ledge)

Blk 13, #01-27

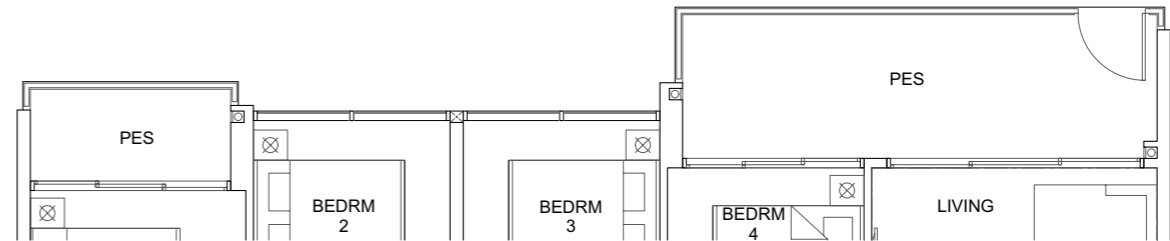

TYPE E1

135m² / 1453ft²
(inclusive of 17m² Balcony
& 6m² AC ledge)

Blk 13, #02-27 to #10-27

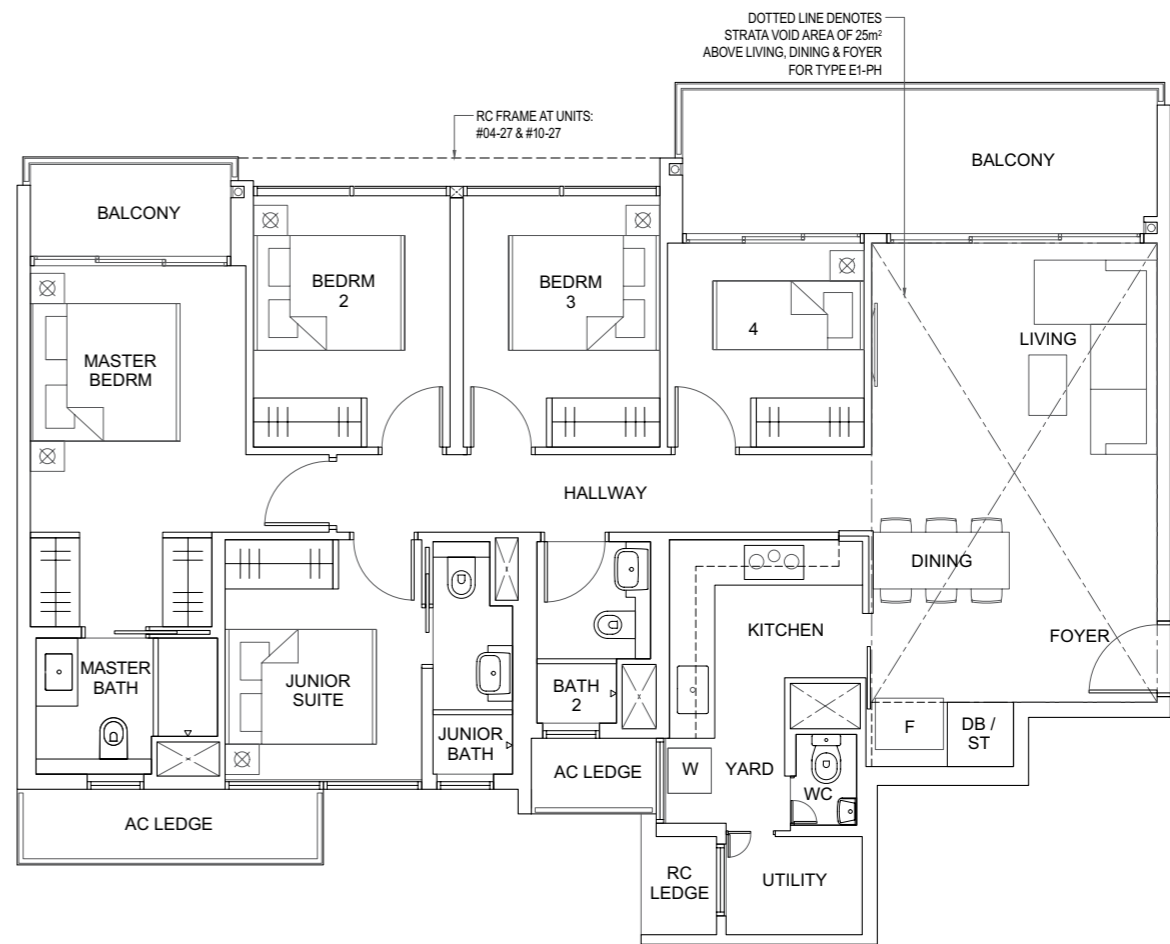

TYPE E1-PH

160m² / 1722ft²
(inclusive of 17m² Balcony
& 6m² AC ledge
& 25m² Void over Living,
Dining & Foyer)

Blk 13, #11-27

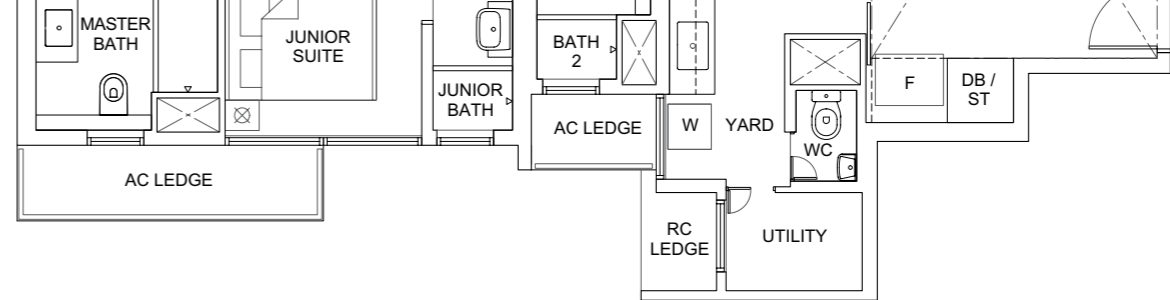

Legend

WC - Water Closet W - Washer F - Fridge DB/ST - Distribution Board / Store

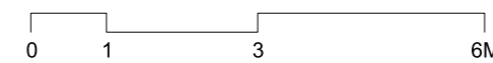

ALL PLANS ARE SUBJECT TO CHANGES BY THE RELEVANT AUTHORITIES.
MEASUREMENTS ARE APPROXIMATE ONLY AND SUBJECT TO FINAL SURVEY.
INFORMATION ACCURATE AT THE POINT OF PRINTING.
BP No.: A0712-05181-2018-BP01 (Dated 2 Dec 2019)

